

# SCREEN CONFIGURATION SUMMARY

SCREEN: 4051408602958

DELUXX Cinema Electric High Contrast Screen Tension II 300 x 169 cm, 135" - DAYVISION ALR

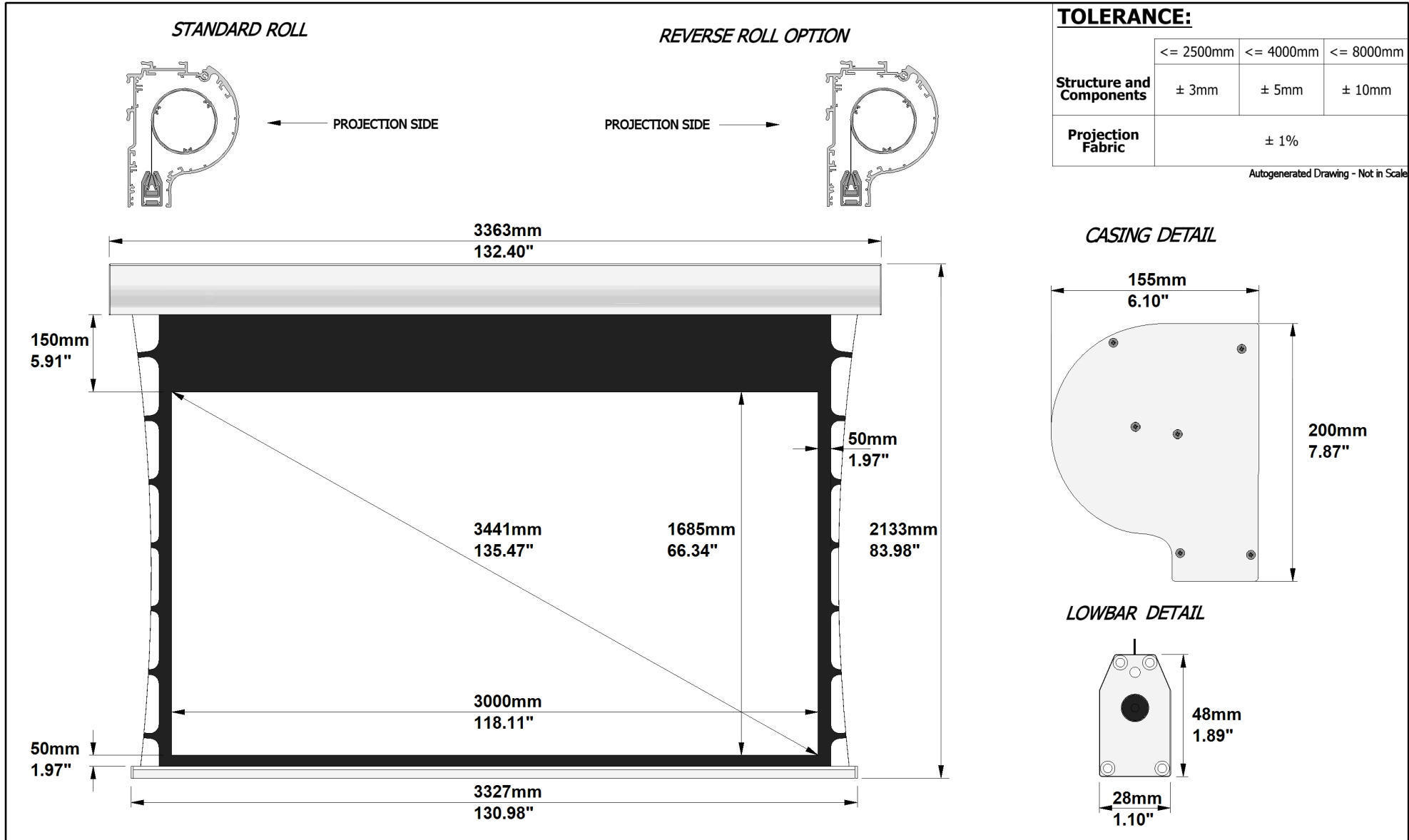

**TOLERANCE:**

	<= 2500mm	<= 4000mm	<= 8000mm
<b>Structure and Components</b>	± 3mm	± 5mm	± 10mm
<b>Projection Fabric</b>	± 1%		

Autogenerated Drawing - Not in Scale

# SCREEN CONFIGURATION SUMMARY

SCREEN: 4051408602958

DELUXX Cinema Electric High Contrast Screen Tension II 300 x 169 cm, 135" - DAYVISION ALR

Autogenerated Drawing - Not in Scale

## MOUNTING BRACKETS AND INSTALLATION VIEW:

QUANTITY OF BRACKETS FOR SCREEN
2

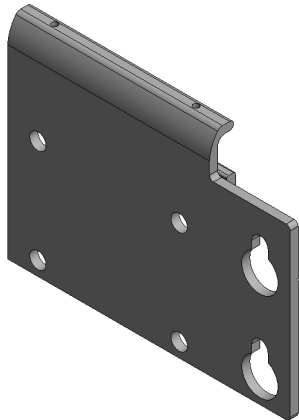
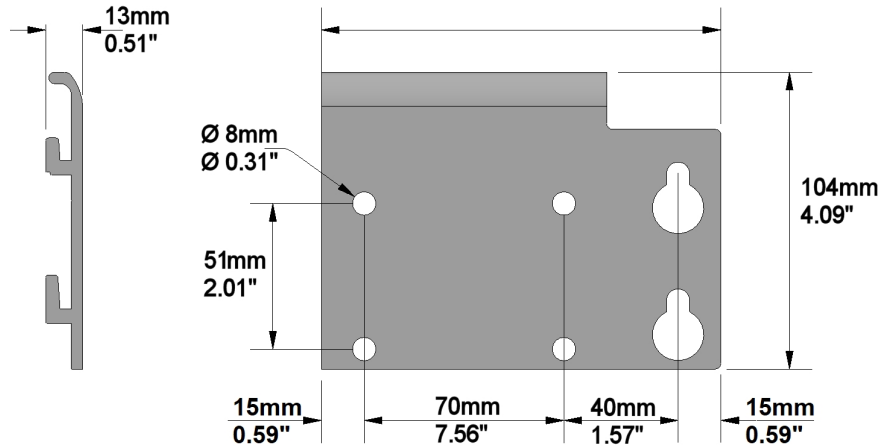

**! IMPORTANT: BRACKET SECURING SCREWS MUST BE USED. NOT DOING SO RISKS CASING FALLING !**

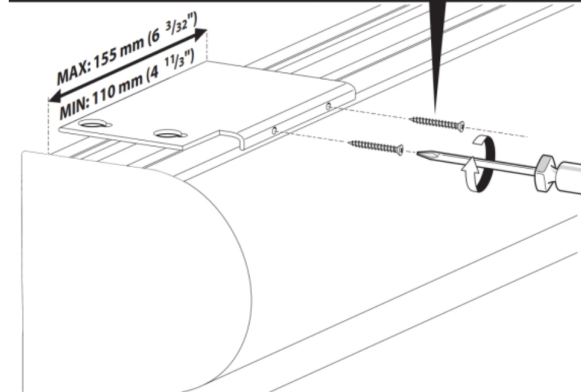

## PACKAGING INFORMATION:

	SHIPPING DIMENSIONS				NUMBER OF BOXES	TOTAL SHIPPING WEIGHT	
	LENGTH	DEPTH	HEIGHT	PALLET HEIGHT		kg	lbs
mm	3443mm			110mm	1	kg	70.80
inches	135.55"			4.33"		lbs	155.76

## MOUNTING OPTIONS:

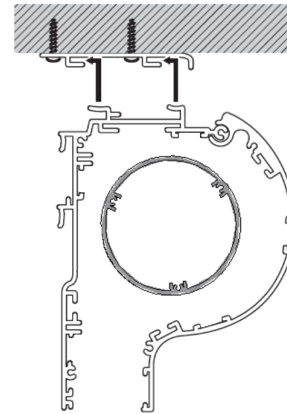

**Ceiling Mounting**

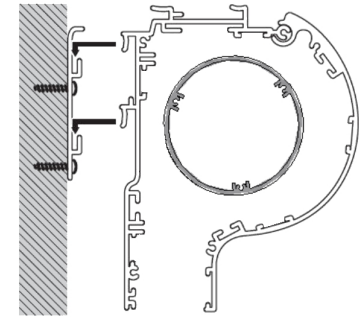

**Wall Mounting**

## MINIMUM CLEARANCE FOR WALL OR CEILING MOUNTING:

**Wall Mount:**  
min 0.51"  
min 13mm

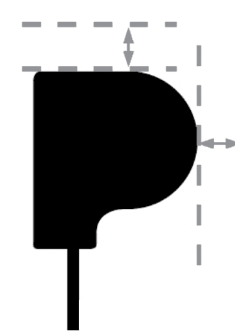

**Ceiling Mount:**  
min 0.51"  
min 13mm